

Owner's Manual

AIR CONDITIONER

Please read this owner's manual carefully before using the air conditioner, and keep this manual for the future reference.

CONTENTS



1.Safety Precaution-----	1
2.Note Before Operation-----	3
3.Cautions-----	5
4.Parts Identification-----	6
5.Operation-----	8
6.Adjustment Air Flow Direction -----	10
7.Maintenance-----	11
8.Abnormal Phenomenon-----	14

- If used as MULTI unit, please refer to the Installation & operation manuals packed with outdoor unit.



SAFETY PRECAUTION

- Please thoroughly read this manual to operate the air-conditioner correctly and safety to prevent the damage of the property and the personal hurt.
Before you come to the text, please be familiar with the following markers and icons, and comply with the precautions.

■ Markers

Markers	Indication
 WARNING	The sign shows the risk of death or serious injury will be caused due to the wrong operation .
 CAUTION	The sign shows the risk of injury or the damage to the property will be caused due to the wrong operation.





■ Icons

Icons	Indication
 FORBID	Followed by the detailed illustration
 ENFORCE	Followed by the detailed illustration



NOTE :



1. Injury means causing from the harm, burn and electrical shock , butnot serious for the hospitalization.
2. The damage of material means the disrepair of property and material.



WARNING



INSTALLATION WARNING	 Installation commitment	Please entrust the dealer or the professional person to do the installation. Users can' t install the units by themselves, or the water leakage, electrical shock or fire may be caused..
	 Please use the specified product.	Accessories must be specified Humidifier and other accessories must be specified, otherwise the water leakage, electrical shock or fire may be caused. Please entrust the professional person to do the installation.
	 Take measure to prevent the refrigerant leakage from the asphyxial accident.	When installing in a small room, actions should be taken in case the thickness of refrigerant exceeding proper range. Otherwise, it will cause people asphyxia. Please contact the dealer to avoid the asphyxial accident.
	 Grounding	Ensure grounding correctly. Defective grounding may cause electrical shock.









 **WARNING**

Using warning	 Forbid	Do not face the cool wind for a long time. Too low temp.will do harm to the health.
	 Forbid	Never put hands or objects into the air conditioner. The fan with the high speed will cause serious injury.
	 Turn off the power.	In any abnormal cases, stop the operation, turn off the power and consult the dealer. In the abnormal cases, if keeping on the operation ,the fire and electrical shock will be caused.

Moving warning	 Forbid	Please entrust the dealer or professional person to move and reinstall the air-conditioner. Incorrect installation will cause water leakage, electrical shock or fire.
	 Forbid	Do not maintain the unit by yourself. Incorrect maintenance will cause water leakage, electrical shock or fire.

Installation caution	 Ensure the drainage.	Ensure if the drain pipe can drain the water well. Incorrect installation will cause water leakage and humidify the furniture.
	 Ensure the creepage protection switch.	Ensure the installation of creepage protection switch. The creepage protection switch must be installed. Otherwise, the electric shock will be caused.
	 Ensure the installation place.	Never install the air-conditioner in the place where the flammable gas is easy to leak. If the leakage of flammable gas happens, the fire will be caused around the indoor unit.

User caution	 Ventilate	Ventilation should be operated regularly when using with the flammable appliance. Insufficient ventilation will cause the lack of oxygen.
	 Forbid	Do not put the flammable appliance near the air outlet. It will cause the flammable appliance burn incompletely.
	 Ensure the installation bracket.	Ensure whether the installation bracket has been worn out after being used for a long time. In the case of abrasion to put the unit on the bracket will cause the unit falling and cause people injured.

User caution	 Forbid	Do not wash the air conditioner with water. Electric shock will be caused.
	 Forbid	Do not put animal or plant near the air outlet. It is harm to the animal and plant.
	 Forbid	Do not put the flammable sprayer near the air conditioner or spray the air conditioner directly. The fire will be caused.
	 Forbid	Do not put the container with water on the air conditioner. Immersion of water will reduce the ability of insulation and the electric shock will be caused.
	 Forbid	Do not operate the switch with wet hand. The electric shock will be caused.
	 Forbid	The air conditioner can not be used to conserve food, plant, precision instrument and artworks etc.. It will get the quality worse.
	 Turn off the power	Disconnect the power and stop the operation when repairing. The fan with high speed will cause injury.
	 Use the right fuse	Do not use the fuse whose capacity exceeds the defined value. Using the iron wire or brass wire as fuse can cause the fire and malfunction. The power must use the specified circuit under the rated voltage.

Note Before Operation

Confirm Before Operation

- Make sure that the ground wire is not broken or fallen off.
- Make sure the air filter is installed.
- Turn on the power switch for 12 hours before the operation.

About Heating Capacity

Heating is that the outdoor unit absorbs the outdoor heat then transmit the heat to the indoor unit. When the heating pump starts, the outdoor unit blows the cold air and the outdoor temp. fall.

Defrosting during the Heating Operation

- Under the heating mode ,when frost generating on the outdoor unit the air conditioner starts defrosting automatically. (About 2~10minutes)
- Indoor/Outdoor fan stops the running during the defrosting.

About 3 Minutes Protection

The outdoor unit would not run within 3 minutes during restarting. This is self-protection of the unit.

About Power Off

- All the operations will stop if there is a power off.
- The buzzer of the display will make a sound and the operation indicator will flash when the power is on after a failure.
- Press ON/OFF button to restart the unit.

About Protection Device

When starting the unit compulsorily while the unit does not prepare for the starting, the on/off indicator lights, the protection device is activated and the unit stops.

Heating Capacity Drop

When the outdoor temp. is low the heating capacity drop, please use the air-conditioner with other heating equipments or purchase the digital scroll central air-conditioner auxiliary heating device.

When the Protection Device is Activated

Cooling Operation

- The air Intake and the air outlet of the outdoor unit are blocked.
- Strong wind outside is blowing into the air outlet of the outdoor unit.

Heating Operation

- The air filter is too dirty.
- The air intake and the air outlet of the indoor unit are blocked.

Fan Runs after the Indoor Unit Stopped

To protect the machine, one of the indoor units, which stops the running while the other indoor units are still running, will run its fan at low speed for 3 minutes every 1 hour on cooling operation or every 4 hours on heating operation.

CAUTION

- Confirm the air filter is installed. The heat exchanger would accumulate dust or leak water without the air filter.
- One indoor unit can run alone, or run with other indoor units, but can not run under heating mode while others run under cooling mode.
- This appliance can be used by children aged from 8 years and above and persons with reduced physical, sensory or mental capabilities or lack of experience and knowledge if they have been given supervision or instruction concerning use of the appliance in a safe way and understand the hazards involved. Children shall not play with the appliance. Cleaning and user maintenance shall not be made by children without supervision.
- This appliance is not intended for use by persons (including children) with reduced physical, sensory or mental capabilities, or lack of experience and knowledge, unless they have been given supervision or instruction concerning use of the appliance by a person responsible for their safety.
- Children should be supervised to ensure that they do not play with the appliance.
- If the supply cord is damaged, it must be replaced by the manufacturer, its service agent or similarly qualified persons in order to avoid a hazard.
- Do not operate your air conditioner in a wet room such as a bathroom or laundry room.

CAUTION

Do not disconnect the power.

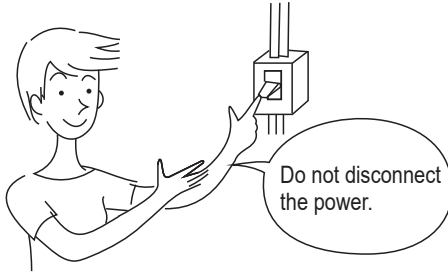

Do not disconnect the power when the unit is in operation. Please control it with the remote controller.

Put the louver horizontally when cooling.

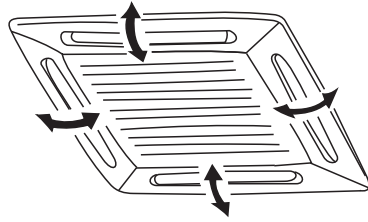

There will be water condensing on the louvers if setting the louvers down when cooling. (Cassette type only)

Connect to the power 12 hours before starting the unit.

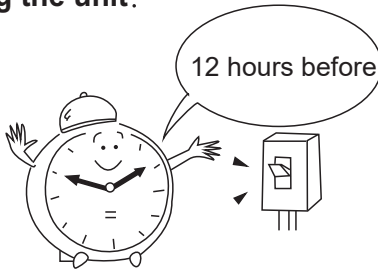

To protect the compressor, please turn on the power switch 12 hours before starting the unit.

Place it away from TV or radio.

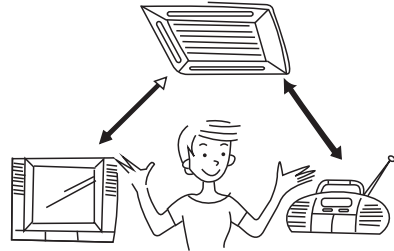

Put the TV or radio away from the air conditioner at least 1 meter, or signal will be interfered.

One of the indoor units can not run on the cooling mode while the other indoor units run on the heating mode.

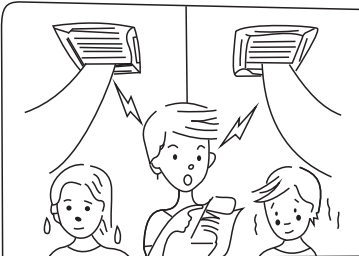

Please run every indoor unit on the same mode.

Parts Identification

Four-Way Cassette Type

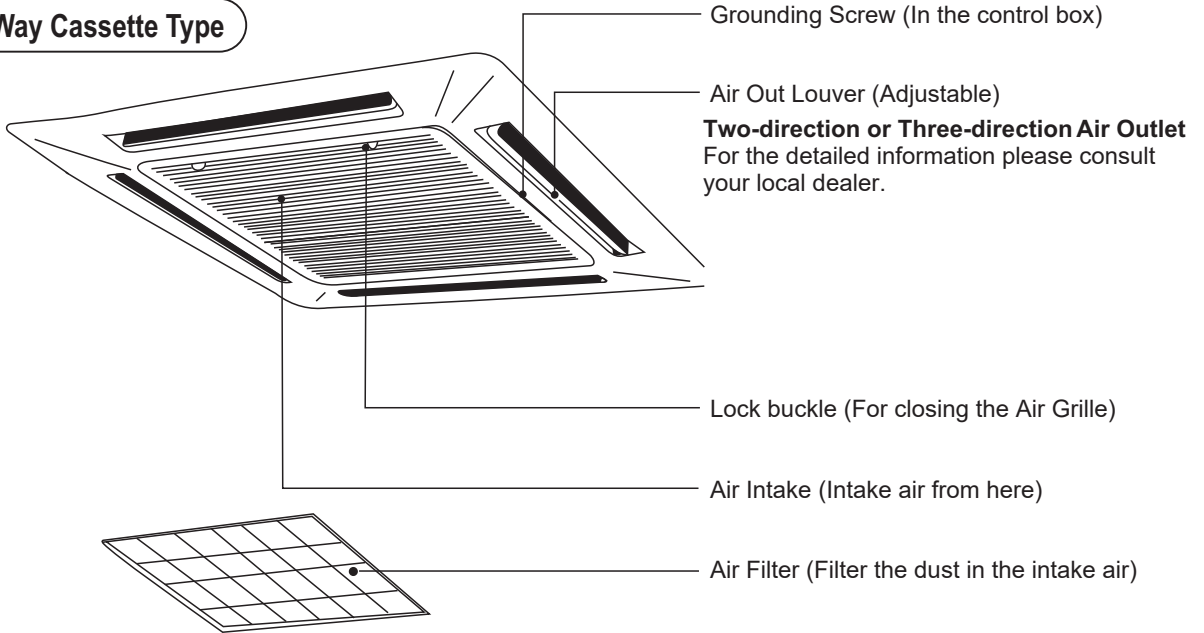

Ceiling-Floor Type

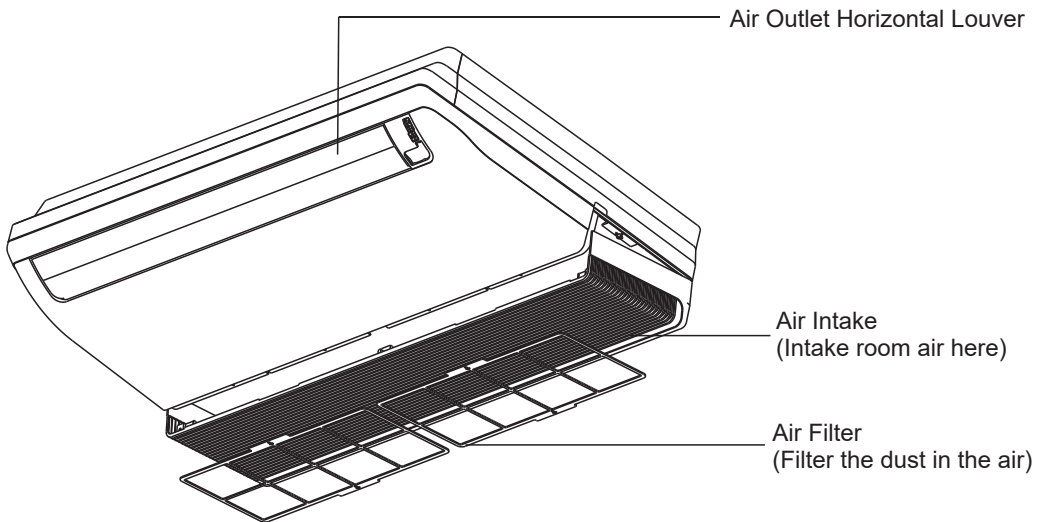

Duct/Ceiling Type

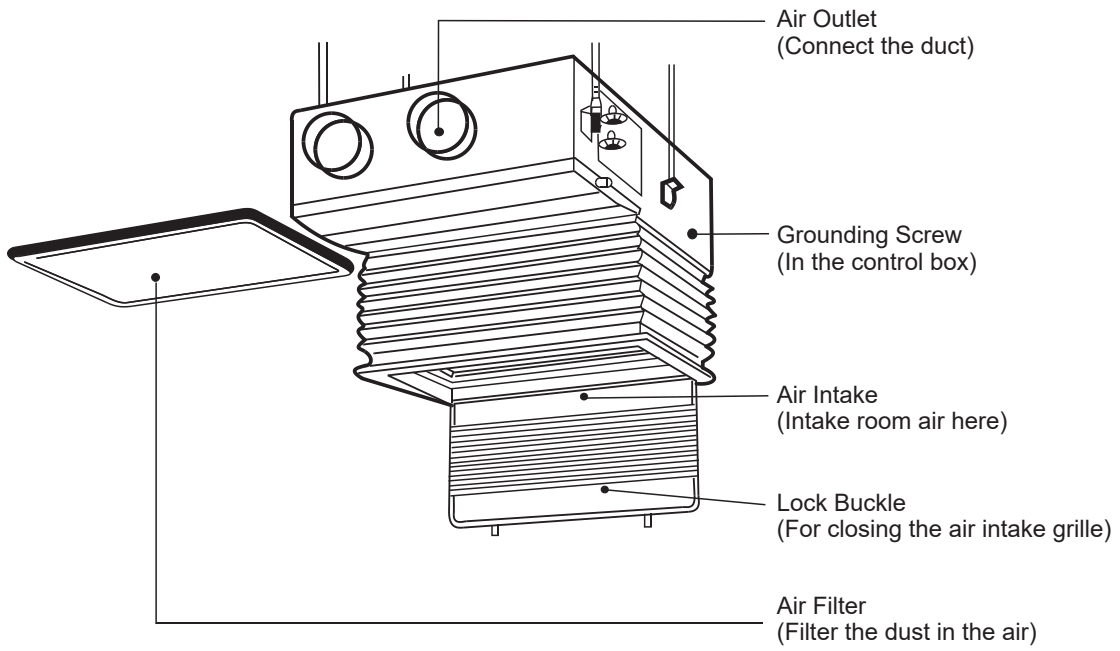

(Thin) Duct/Ceiling Type

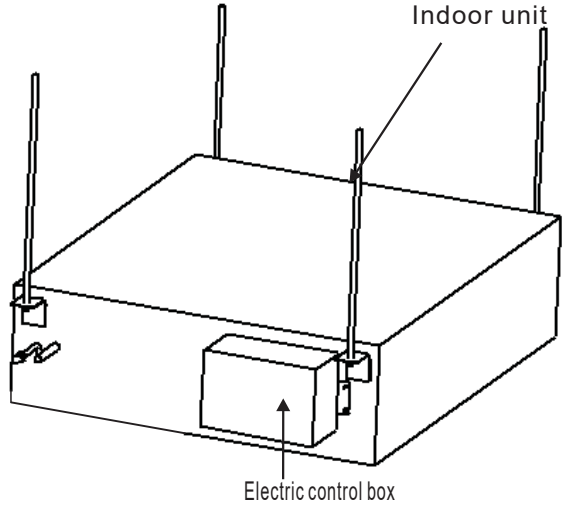
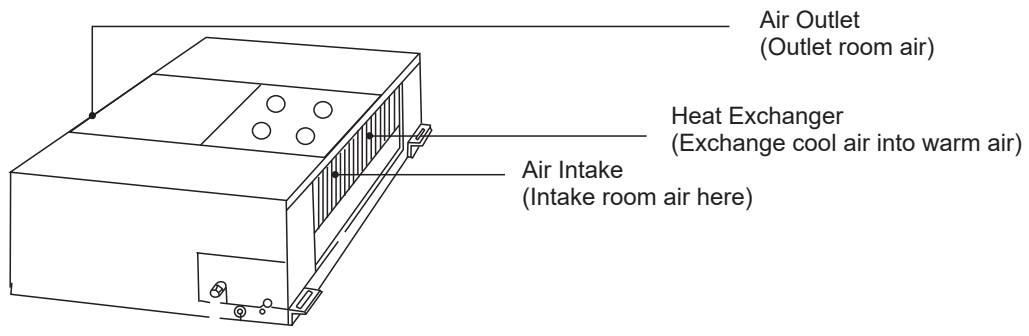

Operation

Please note the following correct operation for saving energy and achieve the quick and comfortable cooling/heating effects.

Clean the air filter regularly

The blocked air filter will reduce cooling/heating effects.

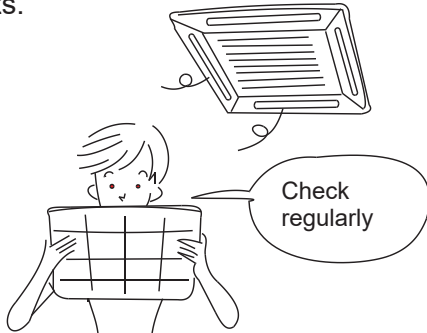

Do not overcool or overheat



Do not expose you to the cool wind for a long time. Over-cool is harm to your health.



Prohibit

- Especially for the handicapped, children or old.

Suggested Temperature

Cooling	26~28°C
Heating	22~24°C



Close the door/window

Do not let the heat/cool air leak from the door/widow.



To maintain the comfortable temperature

- Adjust the air-out direction with using the air-out louver.

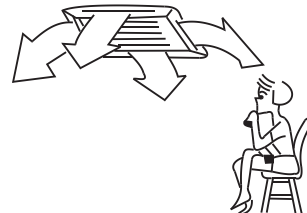

Operation

Operating temperature

Mode	Cooling operation	Heating operation	Drying operation
Room temperature	17°C ~32°C(62°F~90°F)	0°C~30°C(32°F~86°F)	17C ~32C (62F~ 90F)
Outdoor temperature	0°C~50°C (32°F~122°F)	-15°C~ 24°C (5°F~ 76°F)	0°C~ 50°C (32°F~122°F)
	(-15°C~ 50°C/ 5°F~ 122°F): For the models with low temperature cooling system)		

NOTE:

1. Optimum performance will be achieved within these operating temperatures. If a fair conditioner is used outside of the above conditions, certain safety protection features might come into operation and cause the unit to function abnormally.
2. Room relative humidity less than 80%. If the air conditioner operates in excess of this figure, the surface of the air conditioner may attract condensation. Please set the vertical air flow louver to its maximum angle (vertically to the floor), and set HIGH fan mode.

Suggestion: For the unit that adopts an Electric Heater, when the outside ambient temperature is below 0°C(32°F), we strongly recommend you to keep the machine plugged in to order to guarantee it running smoothly.

Special functions

Refrigerant Leakage Detection(optional):

With this new technology, the display area will appear 'EC' (if applicable) and the LED indication lamps continue flashing when the outdoor unit detects refrigerant leakage.



Louver Angle Memory Function(optional):

For some models, the machine is specially designed with louver angle memory function. Power failure during operation or pressing the ON/OFF button on the remote controller will stop the unit completely. When the power restores or pressing the ON/OFF button on the remote controller again, the unit restarts automatically with the previous open angle of the horizontal louver by the memory function. We strongly recommend that the open angle of the horizontal louver should not be set too small, in case the condensed water forms and drops from the horizontal louver. Press the Manual control button and the open angle of the horizontal louver will be restored to the standard angle.

ADJUSTING THE AIR FLOW DIRECTION

Because cold air flow down and hot air flow up, to improve the cooling and heating effect, please adjust air flow louver direction , in result the temperature of the room will be natural and equal and you will fell more comfortable.

NOTE : *The heating operation with horizontal air out let will increase the difference of the room temperature.*

 Notice	 Notice the louver direction	Choose horizontal outlet mode when cooling operation When the cooling operation ,the air flow down will cause condensing dew on the air outlet and louver surface.
--	---	--

Four-Way Cassette Type

Cooling operation

Adjust the louver horizontally .



Heating operation

Adjust the louver down.

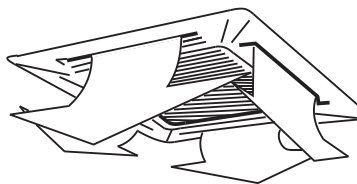

- When using the panel with auto.louver, press SWING button , the auto.louver will swing automatically and the best cooling(heating) effects will be achieved.

Duct-Ceiling Type

The following is how to adjust the air flow direction when the air outlet parts (sold separately) is used with the indoor unit.

Cooling

To effectively cool the whole room, please adjust the louver horizontally.

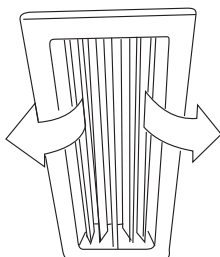

Heating

To effectively heat the bottom of the room please set the louver downwards.

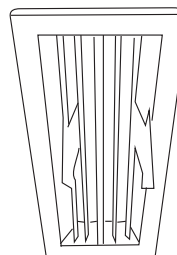

Ceiling-Floor Type

Auto-swing

Press SWING button, the louver will swing up and down(left and right) automatically.

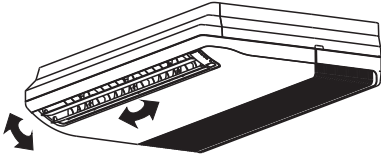

When cooling

Adjust the louver horizontally.

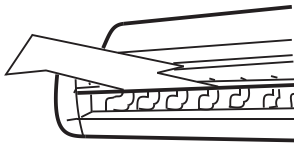

Manual Swing

Adjust the louver to achieve better cooling/heating effects when cooling/heating.

When heating

Adjust the louver downwards (vertically).

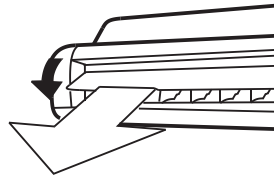

MAINTENANCE

CAUTION

- Only the specialized maintenance person can perform the maintenance work.
- The main power switch must be turned off before doing electrical connection or cleaning the air filter.
- Do not use water or air of temperature above 50°C to clean the air filter or the panel.

METHOD FOR CLEANING THE AIR FILTER

- The air filter can prevent the dust or other particles from going inside. In case of blockage of the filter, the working efficiency of the air conditioner may greatly decrease. Therefore, the filter must be cleaned once two weeks during long time using.
- If the air conditioner is positioned in a dust place, the cleaning frequency of the air filter must be increased.
- If the accumulated dust is too heavy to be cleaned, please replace the filter with a new one (the replaceable air filter is an optional fitting).

1. Take out the air-in grill

- Four-Way Cassette Type

Push the grill switches towards the middle simultaneously as indicated in sketch A. Then pull down the air-in grill. Take out the air-in grill (together with the air filter shown in Sketch B). Pull the air-in grill down at 45° and lift it up to take out the grill.

Cautions: The control box cables, which are originally connected with the main body electrical terminators must be pulled off before doing as indicated above.

The filter cleaning should be performed by a suitable service provider.

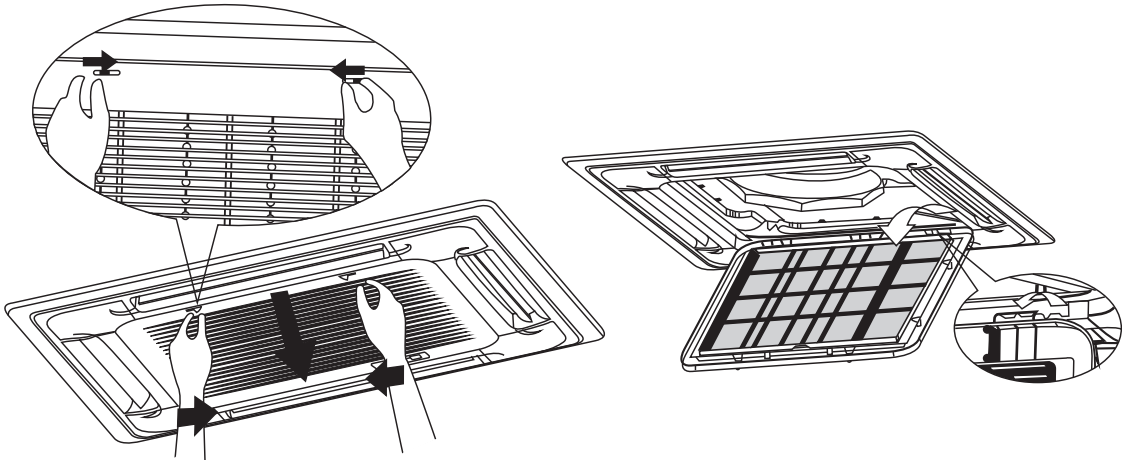

For Duct/Ceiling Type

A

Push the grill switches to the arrow directions , then open the air-in grill downwards. Turn back the air filter fixing block, then take out the air-in grill.

B

2. Dismantle the air filter.
3. Clean the air filter(vacuum cleaner or pure water may be used to clean the air filter. If the dust accumulation is too heavy, please use soft brush and mild detergent to clean it and dry out in the cool place).

MAINTENANCE

- The air-in side should face up when using vacuum cleaner.
- The air-in side should face down when using water.

Cautions : Do not dry out the air filter under direct sunshine or with fire.

For the one-way cassette type , the air filter should be installed before the unit body installation.

4. Re-install the air filter.
5. Install and close the air-in grill in the reverse orders of step 1 and 2 and connect the control box cables to the corresponding terminators of the main body.

CLEANING THE AIR OUTLET AND THE PANEL

- Use a dry and soft cloth to wipe it.
- Pure water or mild detergent may be used if it is very dirty.

CAUTIONS

- Do not use benzene, thinner, polishing power, or similar solvents for cleaning. These may cause the surface to crack or deform.
- To avoid the risk of electrical shock or fire, do not let water fall into the indoor unit.
- Never wipe the air flow louver violently.
- An air conditioner without air filter can not expel the dust out of the room, which would cause malfunctions by accumulation.

MAINTENANCE OF THE OUTDOOR UNIT

1. Injuries may happen by improper operations because of the sharp blade of some plates and the freezer.
2. Check the air outlet and the air inlet of the outdoor unit regularly to ensure that they are not choked by filth or soot.
3. The coil and other parts of the outdoor unit should also be checked regularly. Please contact with your local dealer.

IF YOU DO NOT PLAN TO USE THE UNIT FOR A LONG TIME

- Operate the fan for about half a day to dry the inside of the unit.
- Turn off the unit with the “ON/OFF” button on the remote controller, then disconnect the power .

NOTE

- When the power switch is connected, some energy will be consumed, even if the unit is not in operation. So please disconnect the power to save energy.
- A degree of filth will be accumulated due to certain performance after several seasons of operation. So special maintenance is advised.
- Take out of the batteries from the remote controller.

RESTART AFTER A LONG TIME

1. Check before operation

- Check the air outlets or inlets of the indoor/ outdoor unit are not blocked.
- Check the grounding wire is not broken off and is connected well.

2. Restore the air filter and the front panel

The air filter and the front panel must be fixed to the original position after having been cleaned.

3. Connect the main power switch





To protect the air conditioner, power should be provided 12 hours before operation. Then the OPERATION lamp on the control box of the indoor unit will flash once a second.

AIR-CONDITIONER AUXILIARY HEATING EQUIPMENT

In winter, due to the difference of the area and building construction, please purchase the indoor unit with auxiliary heating to enlarge the heating capacity. When turning to the heat mode the air-conditioner with auxiliary heating will run at the set temp. .It's no need to install auxiliary heating equipments on site for 4-way cassette type and duct/ceiling type (with auxiliary heating).

ABNORMAL PHENOMENON

Please read the following illustration before applying for the service:

Troubles	Causes
<p>From outdoor unit</p> <ul style="list-style-type: none"> ● white cold fog and condensing dew. ● hiss and poop are heard. <p>From indoor unit</p> <ul style="list-style-type: none"> ● Hiss for once. ● Hiss and poop are heard. ● Abnormal smell blown out. ● Operation lamp flashes. <p>Noise, hydrometeor and cold air appear when the running stops.</p> <ul style="list-style-type: none"> ● 'Ksha' can be heard when start.  	<ul style="list-style-type: none"> ● Fan function stop automatically to defrost. It is the start and stop sound of the electro-magnetic valve. ● At the beginning and ending of the running process, sounds like water flow in valve appears, and be enhanced at the first 2~3 minutes, this is refrigerant flow sound. ● Slight hiss and poop are caused by mild flexing of the heat exchanger as temperature changes. ● Pieces of the wall, carpet, furniture, cloth, cigarette and cosmetics adhere to the unit. ● Connect to the power after the power cut. ● Other equipments heating process stops the cooling operation. ● The operator sets an opposite mode against the fixed cooling and heating mode. ● The refrigerant will suddenly move to avoid resorting in the indoor unit, then caused kak sounds. Hydrometeor or cold air appears when other indoor unit is heating or cooling. ● The sound of the expansion valve when supplied power.
<p>Stop running automatically.</p>	<ul style="list-style-type: none"> ● If the timer reached the set time.
<p>No operation</p>  	<ul style="list-style-type: none"> ● If no power. ● If the fuse is blown. ● If starting the protection device (the operation lamp lights). ● If the timer is on the set time. ● If choosing the cooling and heating simultaneously.
<ul style="list-style-type: none"> ● Insufficient cooling ● Insufficient heating 	<ul style="list-style-type: none"> ● If the outdoor unit air inlet or outlet is blocked. ● If the doors and windows are open. ● If the dust filter is choked by collective dust. ● If the air louver is in the right place. ● If the fan speed is shifted in low or if the shift is under FAN mode. ● If the setting temperature is appropriate.

If the air- conditioner is found any failures as mentioned below, please turn off the power immediately. Then contact the local dealer.

- ON/OFF operation is not valid.
- Fuse or leakage protector frequently blown.
- Some matter or water falls into the unit.
- Still no operation after checking the protector(P4).
- Quite different from other indoor unit or ordinary state.



ALPICAIR

FEEL COOL

WWW.ALPICAIR.COM