

Please read this manual carefully before operating the unit and keep it for future reference.

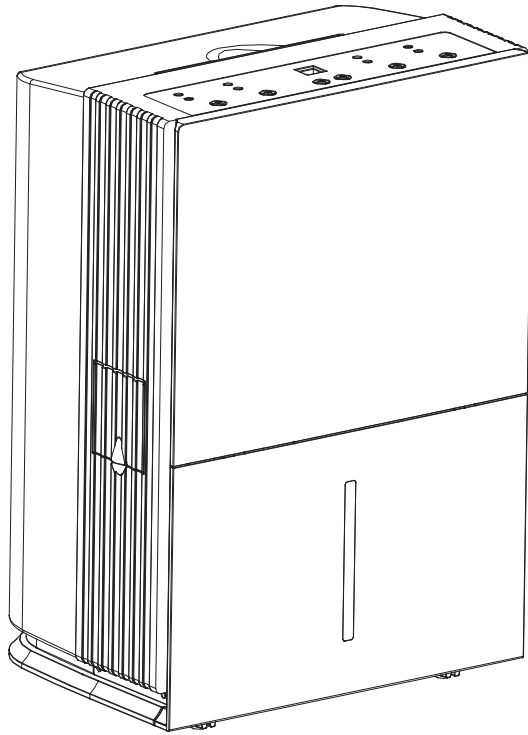

Owner's Manual



Model:

AR-24TR1

DEHUMIDIFIER

CONTENTS

Safety Instructions	2
Operating Instructions	
About the controls on the dehumidifier.....	3
How the Dehumidifier Operates.....	5
Automatic Defrost.....	5
Choosing a Location.....	5
Removing Collected Water.....	6
Water Level.....	6
Care and cleaning of the dehumidifier	
Grille and Case.....	7
Water Bucket.....	7
Air Filter.....	7
Troubleshooting	8
Long term storage	9
Electric schematic diagram	9
Specifications	9

IMPORTANT INSTRUCTIONS

Do not install and use your dehumidifier before completely reading these instruction .

This will help you optimize the operation of your dehumidifier .

The following advice and instructions should be followed closely:

1. Your unit must always be used in an upright position because it contains cooling agent.
2. After unpacking Your unit, place the unit upright to allow the cooling agent to stabilize , and wait 2 hours before use .
3. This product must not be disposed together with the domestic waste. This product has to be disposed at an authorized place for recycling of electrical and electronic appliances.
4. The appliance shall not be installed in the laundry.
5. The appliance shall be installed in accordance with national wiring regulations and must be positioned so that the plug is accessible.
6. If the power cord is damaged, it must be replaced by the manufacturer, service agent or qualified person in order not to get any dangers.
7. Please check before the first operation: Check if the floater on bucket is at right position. If the position is not correct, move it by hand to the right position.

Failure to comply with these instructions may damage the unit and will invalidate the warranty .



IMPORTANT SAFETY INFORMATION. READ ALL INSTRUCTIONS BEFORE USING.

⚠ WARNING!

For your safety, the information in this manual must be followed to minimize the risk of fire, electric shock or personal injury.

SAFETY PRECAUTIONS

When using this dehumidifier, always follow basic safety precautions, including the following:

- Always operate the product from a power source of the same voltage ,frequency and rating as indicated on the product identification plate .
- Close supervision is necessary when any product is used by or near children or invalids .Do not allow children to use it as a toy .
- Do not operate any product with a damaged cord or plug, or after the product malfunctions, or is dropped or appears damaged in any way. Return the complete product to the place of purchase for inspection, repair or replacement.
- Never connect the unit to a defective socket.
- To avoid tripping the circuit, DO NOT USE AN EXTENSION CORD FOR THIS UNIT.
- Make sure that the unit is correctly connected before turning on the unit's power. Never lay down the unit while it is working.
- Always keep it in an upright position to avoid any damage to the unit.
- Switch off and unplug from outlet when not in use or before cleaning.
- Do not place the power cord under a carpet.
- Never install the unit in direct sunshine.
- Prevent children from climbing on the unit.
- To turn on your unit, always use the switch on the control panel.
- Never unplug the dehumidifier while it is working, This could damage the electronic circuits.
- Never place anything on top of the unit and do not cover it with any kind of cloth while it is plugged in or in-use.
- Do not place objects on the product or allow objects to obstruct the inlet or outlet openings, or operate in close proximity to walls or curtains, etc.
- The use of attachments or accessories not recommended or sold by the product distributor may cause personal or property hazards or injuries.
- Keep the area around the warm air outlet sufficiently clean and make sure that it is not congested.
- This product is intended for normal domestic /household use only.
- Repairs should only be carried out by competent service department.
- This appliance is not intended for use by persons (including children) with reduced physical, sensory or mental capabilities,or lack of experience and knowledge, unless they have been given supervision or instruction concerning use of the appliance by a person responsible for their safety.
Children should be supervised to ensure that they do not play with the appliance.

About the controls on the dehumidifier.

Control type 1

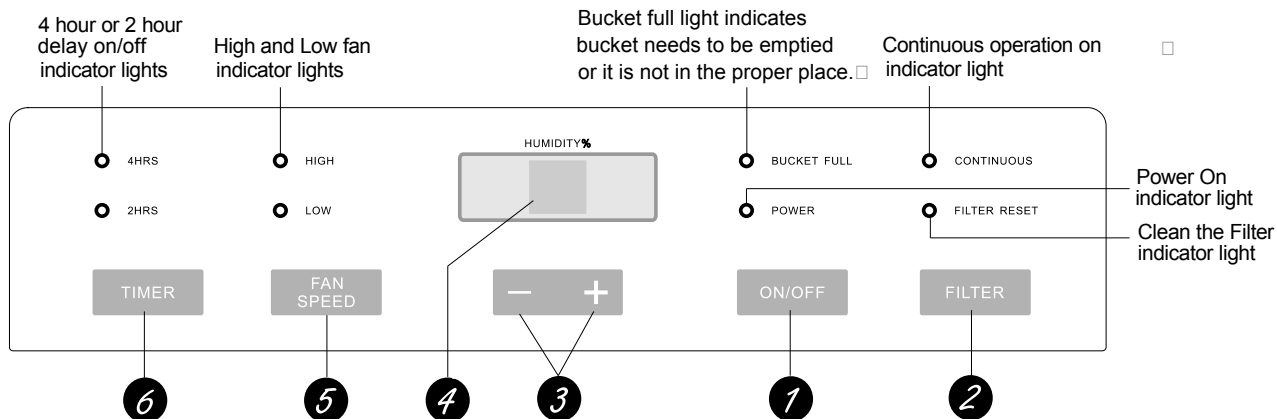

Controls

NOTE: When the bucket is full or removed, the controls cannot be set.

1 ON/OFF Pad
Press to turn the dehumidifier on and off.

2 FILTER Pad
After 250 hours of operation, the **Clean the Filter** indicator light will glow to remind you to clean the filter. Remove the filter and clean it. Press to turn off the **Clean the Filter** light. See the *Care and Cleaning* section.

3 Humidity Set Control Pads
The humidity level can be set within a range of 80% RH (Relative Humidity) to 35% RH (Relative Humidity) in 5% reduce or at **CO** for continuous operation.

NOTE: If **CO** (Continuous) is selected, the dehumidifier will operate continuously at its maximum dehumidification settings if attached to a hose to drain or until the bucket is full.

For drier air, press the - pad and set to a lower percent value (%).

For damper air, press the + pad and set to a higher percent value (%).

When you first use the dehumidifier, set

the humidity control to 45% or 50%. Allow at least 24 hours for the dehumidifier to achieve the humidity level. If you still have damper air than desired, set the humidity level to a lower setting or select Continuous for maximum dehumidification.

This unit has 3-min lag due to the device for protecting circuit. In order to prolong the compressor's working life, the compressor will not start until the unit has run for 3 minutes.

4 Display
Shows the set % humidity level while setting, then shows the actual (+/- 5% accuracy) room % humidity level.

5 FAN SPEED Pad
Controls the fan speed.

Press to select either **High** or **Low** fan speed.

Set the fan control to **High** for maximum moisture removal. When the humidity has been reduced and quiet operation is preferred, set the fan control to **Low**.

6 TIMER Pad
If unit is turned on and running in timer mode for 2hr or 4hr, can turn off the unit. When unit stand by and running in timer mode for 2hr or 4hr can turn on the unit.

Other Features

BUCKET FULL Light

Glow when the bucket is ready to be emptied, or when the bucket is removed or not replaced in the proper position.

Alarm

If the bucket is full or missing for more than three minutes, an alarm will sound for about 10 seconds to remind you to empty and replace the bucket.

Auto Shut Off

The Water Level Control Switch shuts off the dehumidifier when the bucket is full, or when

the bucket is removed or not replaced in the proper position.

Auto Defrost

When frost builds up on the evaporator coils, the compressor will cycle off and the fan will continue to run until the frost disappears.

Power Outage

In the case of a power outage or interruption, the unit will automatically re-start, in the settings last used, after the power is restored.

About the controls on the dehumidifier.

Control type 2

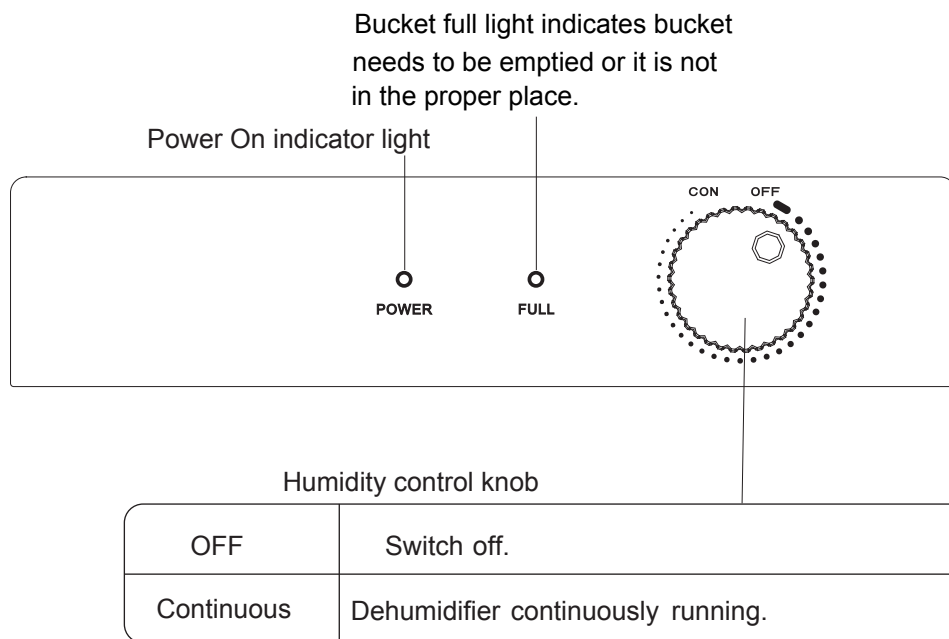

Controls

NOTE: When the bucket is full or removed, the controls cannot be set.

- 1 Make sure the water tank is correctly positioned. (If the bucket full lamp illuminates when the unit is first switched on, remove the bucket and replace it .)
- 2 Turn the humidity control knob to the desired setting (NORMAL) or CONTINUOUS to work.
- 3 The unit will shut down when turned to OFF position.

Other Features

BUCKET FULL Light

Glows when the bucket is ready to be emptied, or when the bucket is removed or not replaced in the proper position.

Auto Shut Off

The Water Level Control Switch shuts off the dehumidifier when the bucket is full, or when the bucket is removed or not placed in the proper position.

Power Outage

In the case of a power outage or interruption, the unit will automatically re-start, in the settings last used, after the power is restored.

Using the dehumidifier.

When first using the dehumidifier, operate the unit continuously 24 hours.

How the Dehumidifier Operates

Moist, humid air is drawn over a cold refrigerated dehumidifying coil. Moisture in the air condenses on this coil and drains into a bucket (or through a hose and drain).

Dry, clean air is drawn through the condenser where it is heated and discharged out the top grille into the room.

It is normal that the surrounding air to become slightly warmer as the dehumidifier operates.

Automatic Defrost

When frost builds up on the evaporator coils, the compressor will cycle off and the fan will continue to run until the frost disappears.

In defrosting mode, fan motor normally run, compressor stop running.

Choosing a Location

A dehumidifier operating in a basement will have little or no effect in drying an adjacent enclosed storage area, such as a closet, unless there is adequate circulation of air in and out of the area.

- **Do not use outdoors.**
- **This dehumidifier is intended for indoor residential applications only. This dehumidifier should not be used for commercial or industrial applications.**
- **Place the dehumidifier on a smooth, level floor strong enough to support the unit with a full bucket of water.**
- **Allow at least 12–18 inches of air space on all sides of the unit for good air circulation.**
- **Place the dehumidifier in an area where the temperature will not below 5°C. Or the coils can become covered with frost ,which may reduce performance.**
- **Use the dehumidifier to prevent moisture damage anywhere books or valuables are stored.**
- **Use the dehumidifier in a basement to help prevent moisture damage.**
- **The dehumidifier must be operated in an enclosed area to be most effective.**
- **Close all doors, windows and other outside openings of the room.**

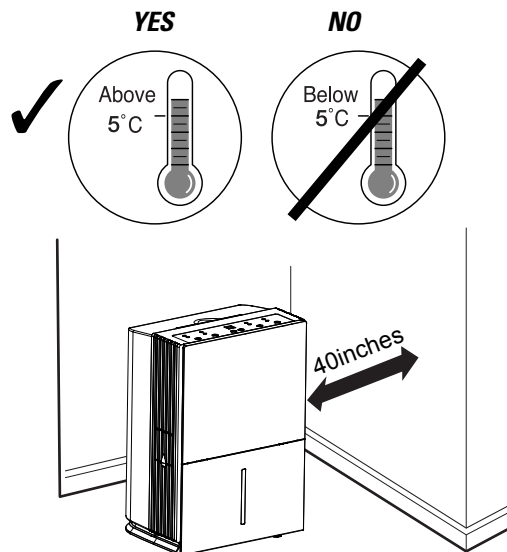

NOTE: The dehumidifier has rollers to aid placement, but it should only be rolled on smooth, flat surfaces. Do not attempt to roll the dehumidifier on carpet or over objects.

Using the dehumidifier.

Always make sure the water bucket is locked into place on the dehumidifier.

Removing Collected Water

There are 2 ways to remove collected water:

- 1 **Use the bucket.** When the bucket is removed, the unit will shut off. Empty and replace the bucket.

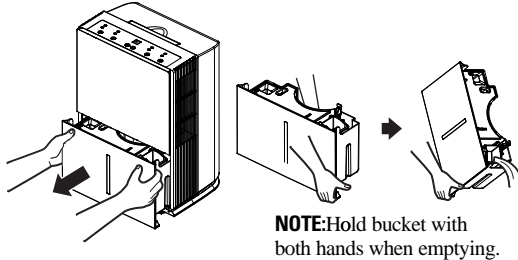

Important: Do not use the hose if using the water tank to collect water. When the hose is connected, water will be drained out through it onto floor instead of into the tank.

NOTES:

- Do not remove the bucket while the unit is in operation or it has just stopped. Otherwise it may cause some water to drip from the draining pan.
- The bucket must be in place and securely seated for the dehumidifier to operate.

- 2 **Use a hose.** Water will automatically flow into a floor drain by attaching a 14mm inner diameter hose (not included).

1. Open the drain cover on the side of the unit.
2. Thread the drain tie-in (supplied) onto the nozzle.
3. Connect the hose to the drain tie-in, and lead it to the floor drain.

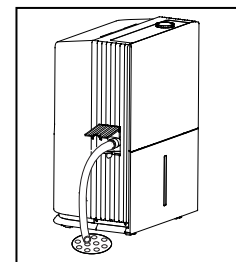
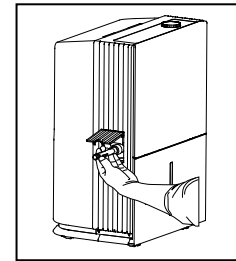
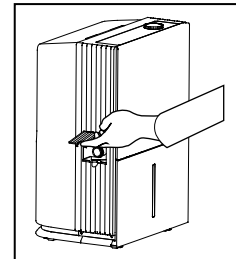

Water Level

The dehumidifier will turn off automatically when the bucket is full, or when the bucket is removed or not replaced in the proper position.

The bucket must be replaced in the proper position for the dehumidifier to work. The light will be on and the dehumidifier will not run if the bucket is not in the proper position.

Care and cleaning of the dehumidifier.

Turn the dehumidifier off and remove the plug from the wall outlet before cleaning.

Grille and Case

To clean the case:

Use water and a mild detergent. Do not use bleach or abrasives.

To clean the front grille:

Use a vacuum attachment or brush.

Water Bucket

To clean:

Every few weeks, clean the bucket to prevent growth of mold, mildew and bacteria. Partially fill the bucket with clean water and add a little mild detergent. Swish it around in the bucket, empty and rinse.

NOTE: Do not use a dishwasher to clean the water bucket.

To remove:

Remove the bucket and pour any water out.

To replace:

Slide the bucket into the dehumidifier.

NOTE: The bucket must be in place and securely seated for the dehumidifier to operate.

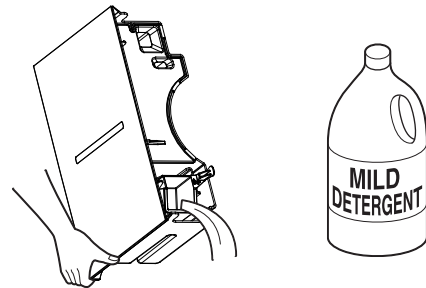

Air Filter

The air filter should be checked and cleaned at least every 250 hours of operation or more often if necessary.

- ※ After 250 hours of operation, the **Clean the Filter** indicator light will glow to remind you to clean the filter. Remove the filter and clean it. Replace the filter and press the **Filter RESET** pad to turn off the **Clean the Filter** light.

To remove:

Press the two buttons, then pull out the filter.

To clean:

Clean the filter with warm, soapy water. Rinse and let the filter dry before replacing it.

To install:

Put the filter back into the dehumidifier.

NOTE: DO NOT rinse or put the filter in an automatic dishwasher.

- ※ (Control Type1 Models only)

▲ Caution: Do not operate the dehumidifier without a filter because dirt will gather and affect the unit's performance.

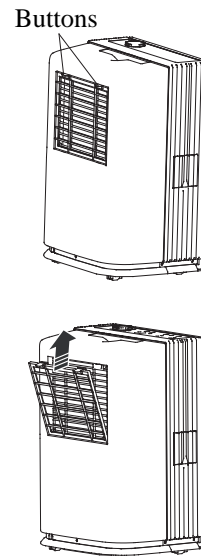

NOTE: Avoid using a dishwasher to clean the filter.

Troubleshooting.

Problem	Possible Causes	What To Do
Dehumidifier does not start	The dehumidifier is unplugged.	<ul style="list-style-type: none"> • Make sure the dehumidifier's plug is pushed completely into the outlet.
	Dehumidifier has reached its preset level or bucket is full.	<ul style="list-style-type: none"> • The dehumidifier automatically turns off when either condition occurs. Change to a lower setting or empty the bucket and replace properly.
	Bucket is not in the proper position.	<ul style="list-style-type: none"> • The bucket must be in place and securely seated for the dehumidifier to operate.
	Power failure.	<ul style="list-style-type: none"> • There is a protective time delay (up to 3 minutes) to prevent tripping of the compressor overload. For this reason, the unit may not start normal dehumidifying for 3 minutes after it is turned back on.
Dehumidifier does not dry the air as it should	Did not allow enough time to remove the moisture.	<ul style="list-style-type: none"> • When first installed, allow at least 24 hours to maintain the desired dryness.
	Airflow is restricted.	<ul style="list-style-type: none"> • Make sure there are no curtains, blinds or furniture blocking the front or back of the dehumidifier. See the <i>Choosing a Location</i> section.
	Dirty filter.	<ul style="list-style-type: none"> • See the <i>Care and Cleaning</i> section.
	The Humidity Control may not be set low enough.	<ul style="list-style-type: none"> • For drier air, press the “-” pad and set to a lower percent value (%) or at CO (continuous) for maximum dehumidification.
	Doors and windows may not be closed tightly.	<ul style="list-style-type: none"> • Check all doors, windows and other openings are securely closed.
	Clothes dryer may be blowing moisture-laden air into the room.	<ul style="list-style-type: none"> • Install the dehumidifier away from the dryer. The dryer should be vented to the outside.
	Room temperature is too low.	<ul style="list-style-type: none"> • Moisture removal is best at higher room temperatures. Lower room temperatures will reduce the moisture removal rate. Models are designed to be operated at temperatures above 5°C.
Dehumidifier runs too much	Area to be dehumidified is too large.	<ul style="list-style-type: none"> • The capacity of your dehumidifier may not be adequate.
	Doors and windows are open.	<ul style="list-style-type: none"> • Close all doors and windows to the outside.
Frost appears on the coils	Dehumidifier has been recently turned on, or room temperature is below 5°C.	<ul style="list-style-type: none"> • This is normal. Frost will usually disappear within 60 minutes. See the <i>Automatic Defrost</i> section.
Controls cannot be set	The compressor will turn off and the fan will automatically continue to run for approximately 3 minutes at a fixed setting.	<ul style="list-style-type: none"> • This is normal. Wait approximately 3 minutes and set the fan as desired.
Fan noise	There is sound created when wind passing the unit. That is the sound of wind.	<ul style="list-style-type: none"> • This is normal.
Water on floor	Hose connection may be loose.	<ul style="list-style-type: none"> • Check the hose connection. See the <i>Removing Collected Water</i> section.
	Intend to use the bucket to collect water, but a hose is attached.	<ul style="list-style-type: none"> • Disconnect the hose if using the bucket to collect water. See the <i>Removing Collected Water</i> section.

Long term storage.

When you do not use the unit for a long period, we suggest you to take following steps to store the unit in a good condition:

- Make sure there is no water left in the water tank and take off the draining hose
- Take off the power cord and plug and wrap them well.
- Clean the unit and packed it well to keep it from dust.

Electric schematic diagram.

AR-24TR1

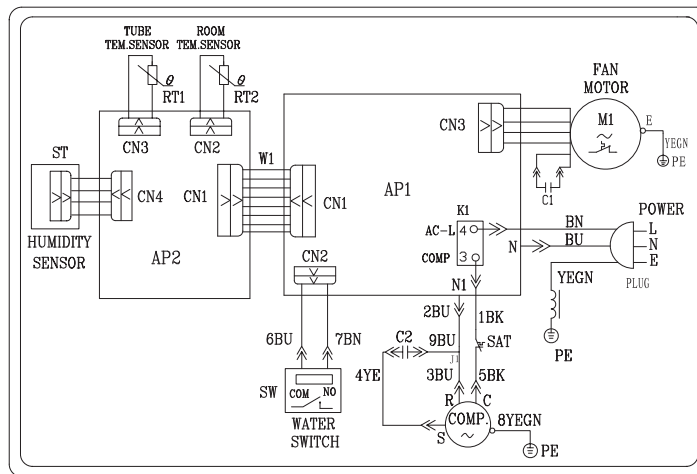

Fuse type 3.15A

Specifications.

Model	AR-24TR1
Rated Voltage	220-240V~
Rated Frequency	50Hz
Rated Power	600W
Moisture Removal	24L/DAY
Operating Temperature	5°C-35°C
Weight	14kg
Tank capacity	4.5L(Automatic stop at about 3.5L)

