

Ceiling/floor type split air conditioner

Indoor unit technical data

MODEL	AFI-140HPS3		
Power consumption	380/3/50		V/ph/Hz
	Cooling mode	Heating mode	
Capacity	14100	15240	W
Power input	5130	5380	W
Max input current	10.5		A
Eficiency (EER/COP)	2.73	2.79	
Refrigerant	R410a (3250 g)		
Ventilator model	YSK59-4D-4(x2)		
Ventilator brand	Welling		
Ventilator air flow	Hi/Med/Low	2000/1800/1600	m3/h
Ventilator power		102/98/96 (x2)	W
Sound Pressure (Lp)	Hi/Med/Low	47/46/44	dB(A)
Net dimensions	LxHxD	1670x680x240	mm
Packing dimensions	LxHxD	1764x760x329	mm
Weight	brutto/neto	58/50	kg
Pipe connections	liquid/gas	1/2 - 3/4	inch
	indoor condensate	25	mm
Piping distance	max lenght	25	m
	max diff level	15	m
	indoor&outdoor	5 x 4.0	mm2
Electrical connections	indoor & outdoor signal	2 x 1.5	mm2
	power to indoor	3 x 4.0	mm2

Outdoor unit model to been used

AOU-140HPS3

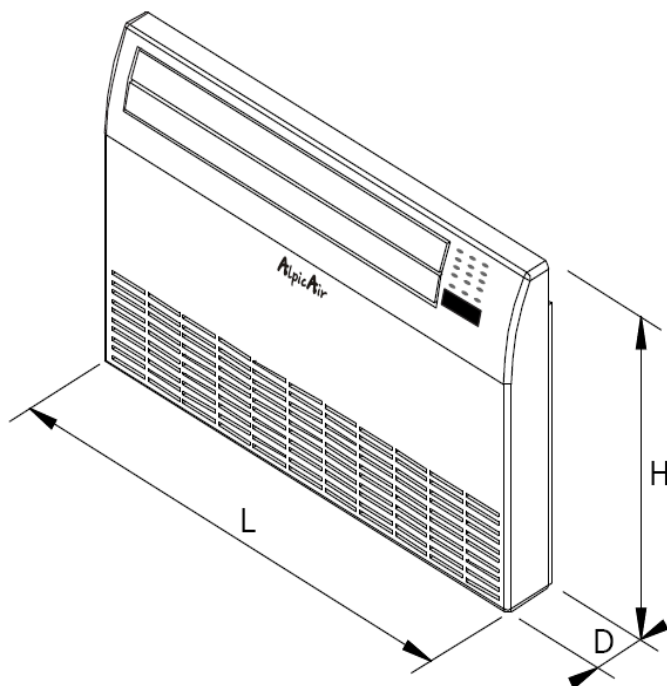

AFI-140HPS3