

Ducted type split air conditioner

Indoor unit technical data

MODEL	ATI-140HPS3		
Power consumption	380/3/50		V/ph/Hz
	Cooling mode	Heating mode	
Capacity	14000	15000	W
Power input	5165	5395	W
Max input current	10.8		A
Eficiency (EER/COP)	2.71	2.78	
Refrigerant	R410a (3250 g)		
Ventilator model	YSK59-4A(x2)		
Ventilator brand	Welling		
Ventilator air flow	Hi/Med/Low	2400/2300/2200	m3/h
Ventilator power	104/87/78 (x2)		W
Sound Pressure (Lp)	Hi/Med/Low	51/47/44	dB(A)
Net dimensions	LxHxD	1350x298x800	mm
Packing dimensions	LxHxD	1555x370x940	mm
Weight	brutto/neto	57/48	kg
Pipe connections	liquid/gas	1/2 - 3/4	inch
	indoor condensate	25	mm
Piping distance	max lenght	25	m
	max diff level	15	m
	indoor&outdoor	5 x 4.0	mm2
Electrical connections	indoor & outdoor signal	2 x 1.5	mm2
	power to indoor	3 x 4.0	mm2

Outdoor unit model to been used

AOU-140HPS3

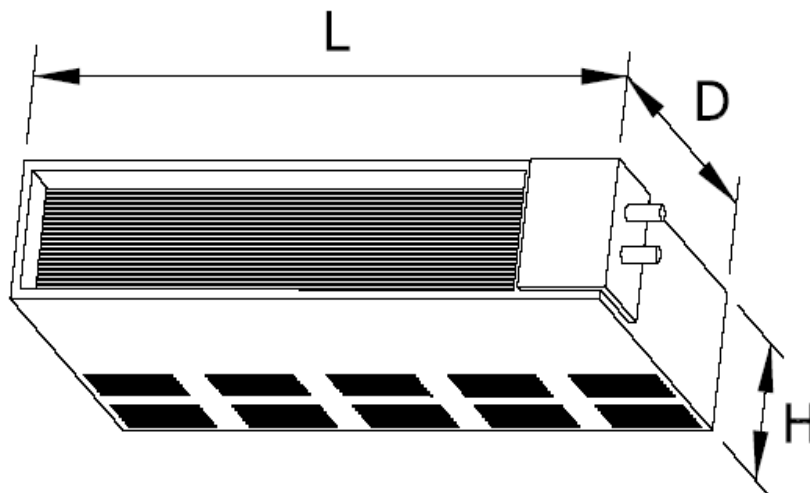

ATI-140HPS3